

CURRENT 3.0 Ampere  
 VOLTAGE RANG 50 to 1000 Volts

## US3ABF THRU US3MBF

### FEATURES

- Plastic package has underwrites laboratory flammability Classification 94V-0
- Glass passivated chip junction
- Built-in strain relief,
- Fast switching speed for high efficiency
- High temperature soldering guaranteed: 250 /10 seconds

### S M B F

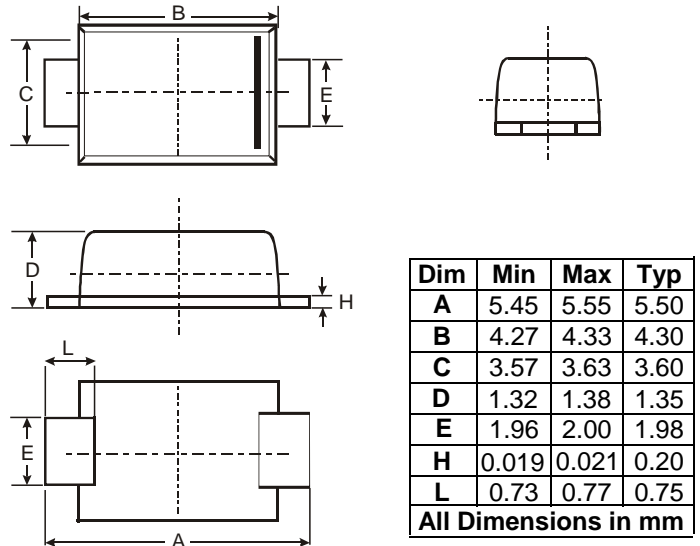

### MECHANICAL DATA

- Case: JEDED SMBF transfer molded plastic
- Terminals: Solder plated, solderable per MIL-STD-750, method 2026
- Polarity: Color band denotes cathode end
- Weight: 0.0018 ounce, 0.090 gram

### MAXIMUM RATINGS AND ELECTRICAL CHARACTERISTICS

- Ratings at 25 ambient temperature unless otherwise specified.
- Single phase, half wave, 60Hz, resistive or inductive load.
- For capacitive load derate current by 20%.

	SYMBOLS	US3A	US3B	US3D	US3G	US3J	US3K	US3M	UNIT
Maximum Repetitive Peak Reverse Voltage	$V_{RRM}$	50	100	200	400	600	800	1000	Volts
Maximum RMS Voltage	$V_{RMS}$	35	70	140	280	420	560	700	Volts
Maximum DC Blocking Voltage	$V_{DC}$	50	100	200	400	600	800	1000	Volts
Maximum Average Forward Rectified Current At $T_L=105$ (NOTE 1)	$I_{(AV)}$	3.0							Amps
Peak Forward Surge Current 8.3ms single half sine-wave superimposed on rated load (JEDEC Method)	$I_{FSM}$	100							Amps
Maximum Instantaneous Forward Voltage at 3.0A	$V_F$	1.0		1.3		1.7			Volts
Maximum DC Reverse Current at rated DC Blocking Voltage at	$T_A = 25$	10							A
	$T_A = 125$	200							
Maximum Reverse Recovery Time Test conditions $I_F=0.5A$ , $I_R=1.0A$ , $I_{RR}=0.25A$	$t_{rr}$	50				100			nS
Typical Junction Capacitance (Measured at 1.0MHz and applied reverse voltage of 4.0V)	$C_J$	80				50			pF
Typical Thermal Resistance (Note 1)	$R_{\theta JA}$	55							/W
	$R_{\theta JL}$	17							
Operating Junction Temperature	$T_J$	(-55 to +150)							
Storage Temperature Range	$T_{STG}$	(-55 to +150)							

#### Notes:

1. Thermal resistance from Junction to ambient and from junction to lead mounted on P.C.B. with 0.3×0.3" (8.0 × 8.0mm) copper pad areas.

CURRENT 3.0 Ampere  
 VOLTAGE RANG 50 to 1000 Volts

**US3ABF THRU US3MBF**

RATING AND CHARACTERISTIC CURVES US3A Thru US3M

FIG.1-TYPICAL FORWARD CURRENT DERATING CURVE

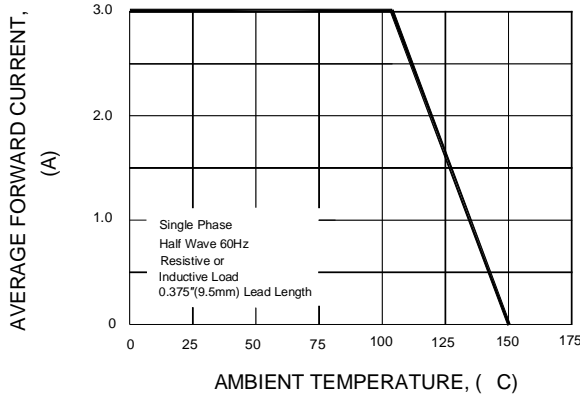

FIG.2-MAXIMUM NON-REPETITIVE PEAK FORWARD SURGE CURRENT

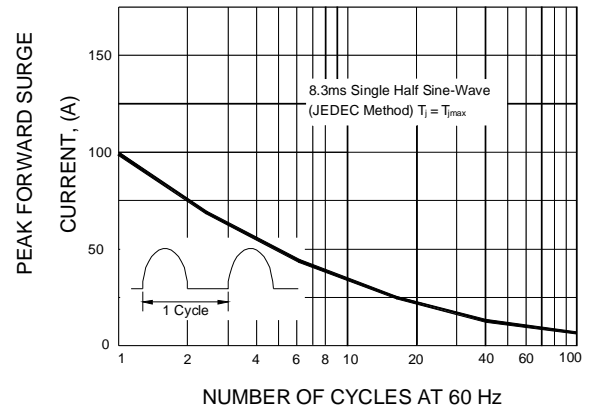

FIG.3-TYPICAL INSTANTANEOUS FORWARD CHARACTERISTICS

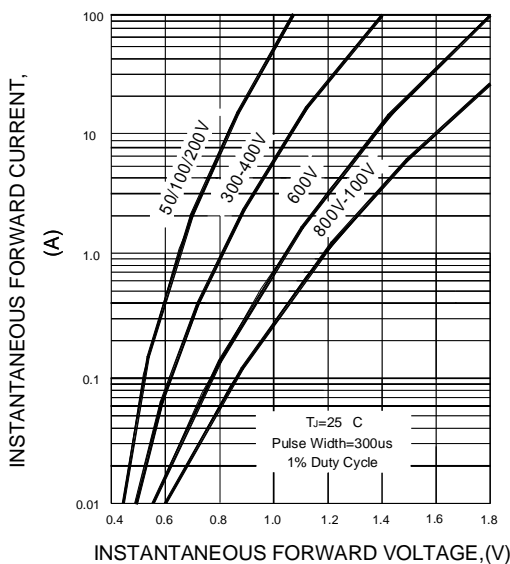

FIG.4-TYPICAL REVERSE CHARACTERISTICS

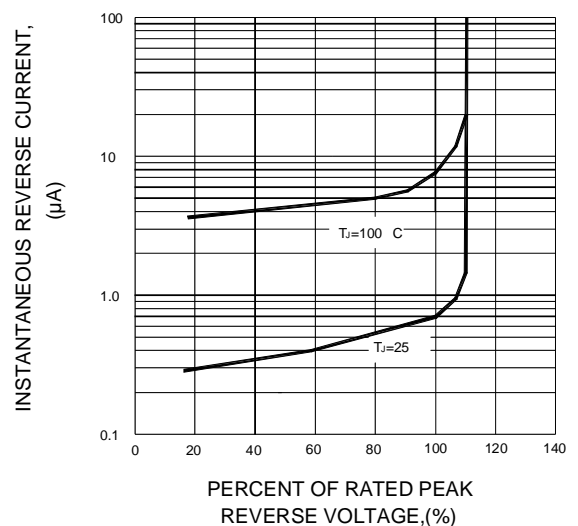

FIG.5-TYPICAL JUNCTION CAPACITANCE

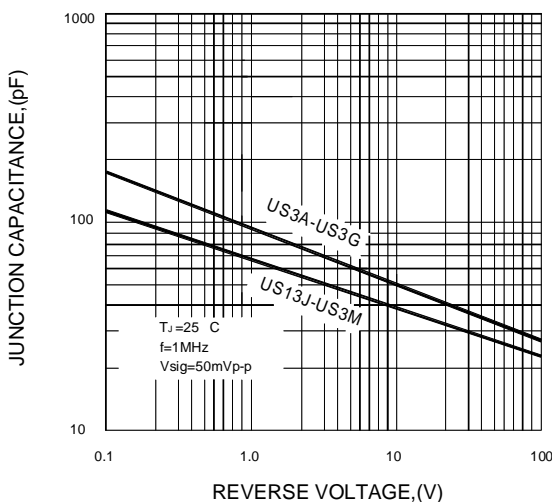
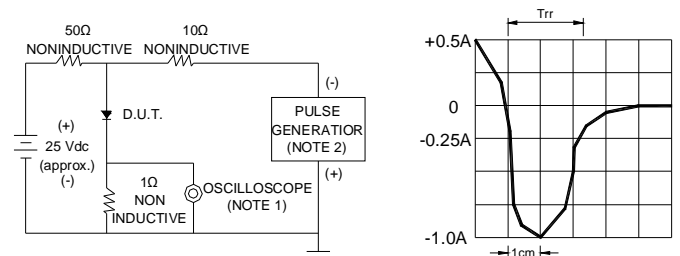

FIG.6-TEST CIRCUIT DIAGRAM AND REVERSE RECOVERY TIME CHARACTERISTIC



NOTES : 1.Rise Time=7ns max. Input Impedance= 1 megohm. 22pF  
 2.Rise time=10ns max. Source Impedance= 50 ohms

SET TIME BASE FOR 50/100ns/cm